



KROS
T E C H N I K



K
I
T

U
D
I
E
N
Z
A

KIT UDIENZA
CATALOGO 07EIES

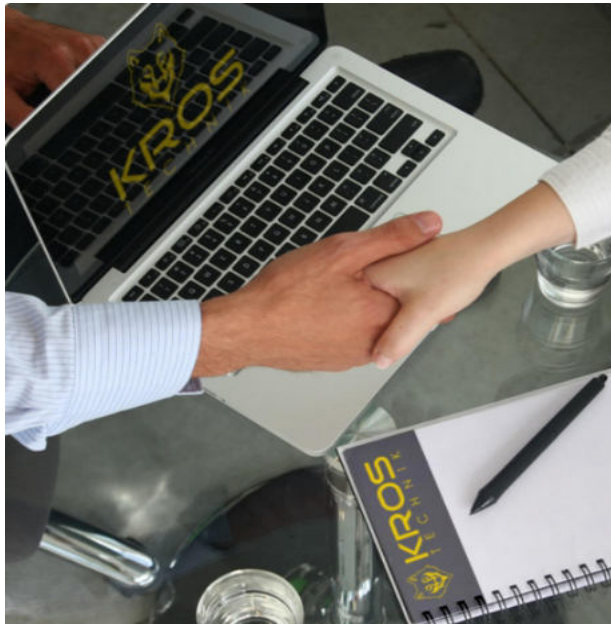

KROS TECHNIK S.R.L.

È un'azienda italiana specializzata nella realizzazione di sistemi di sicurezza. Progetta e produce al suo interno tutti i dispositivi dedicati ai settori antintrusione, antincendio, anti-allagamento e antigas, nel rispetto dell'autentico Made in Italy. Affidabilità, capacità, innovazione sono le motivazioni che rendono KROS TECHNIK un partner sicuro per chiunque desideri prodotti affidabili e competitivi.

Kros Technik Srl is an Italian company specialized in the creation of security systems. In-house, it designs and manufactures all the devices dedicated to the anti-intrusion, fire-fighting, anti-flooding and anti-gas sectors, in compliance with authentic Made in Italy. Reliability, ability, innovation are the reasons that make KROS TECHNIK a reliable partner for anyone who wants reliable and competitive products.

ASSISTENZA CLIENTI

Tutti i nostri articoli vengono venduti con le garanzie del caso e nei nostri laboratori ti aspetta personale altamente qualificato e dotato dei migliori strumenti di diagnostica per far fronte a ogni problema di installazione, riparazione e manutenzione del prodotto acquistato o del progetto che vi occorre.

Per qualsiasi servizio contattaci via email o via telefono:
Tel: +39 0695595017
email: assistenza@krostechnik.it

Customer service.

All our items are sold with the appropriate guarantees and highly qualified personnel await you in our laboratories equipped with the best diagnostic tools to deal with any installation, repair and maintenance problem of the product purchased or the project you need.

For any service contact us by email or by phone:
Phone: +39 0695595017
email: assistenza@krostechnik.it



QUALITY MAKES THE DIFFERENCE

www.krostechnik.it



- Engineering
- Prototipazione
- Realizzazione piccola serie
- Industrializzazione del prodotto

Engineering
Prototyping
Mini-series implementation
Mass production

Kros Technik si rivolge ai seguenti clienti:

Kros Technik target customers are:

- OEM / OEM
- Distributori / Distributors
- Installatori / Installers
- Progettisti / Designers
- Enti / Organizations

PRODUZIONE 100% ITALIANA

La nostra caratteristica è quella di progettare e produrre totalmente MADE IN ITALY. Siamo in grado di progettare, disegnare, prototipare, costruire ed industrializzare qualsiasi prodotto elettronico che occorra. La capacità progettuale, sia elettronica che meccanica, inserisce KROS TECHNIK S.r.l. nel gradino massimo di interesse di ogni azienda che vuole inserire nella propria gamma di prodotti: articoli esclusivi, affidabili ed allo stesso tempo competitivi. La nostra struttura è in grado di soddisfare richieste per piccoli, medi e grandi lotti di prodotto.

Our characteristic is to design and produce totally MADE IN ITALY. We are able to plan, draw, prototype, build and industrialize any electronic product that is needed. The design capacity, both electronic and mechanical, places KROS TECHNIK S.r.l. in the highest level of interest of every company that wants to include in its range of products: exclusive, reliable and at the same time competitive items. Our structure is able to satisfy requests for small, medium and large product batches.

INDICE

• SU RICHIESTA SI POSSONO REALIZZARE SISTEMI PERSONALIZZATI •

KIT SEGNALAZIONE OTTICO-ACUSTICO - UDIENZA "OCCUPATO-LIBERO"	02
OPTICAL-ACOUSTIC SIGNALING KIT - "BUSY-FREE" HEARING	
KIT SEGNALAZIONE OTTICO-ACUSTICO - PRECEDENZA "OCCUPATO-ATTENDERE-LIBERO"	03
OPTICAL-ACOUSTIC SIGNALING KIT - "BUSY-WAIT-FREE" PRIORITY	
KIT SEGNALAZIONE OTTICO-ACUSTICO - PRECEDENZA "STOP-AVANTI"	04
OPTICAL-ACOUSTIC SIGNALING KIT - "STOP-FORWARD" PRIORITY	
KIT SEGNALAZIONE OTTICO-ACUSTICO - PRECEDENZA "LIBERO-OCCUPATO-ATTENDERE" 503	06
OPTICAL-ACOUSTIC SIGNALING KIT - "FREE-BUSY-WAIT" PRIORITY 503	

1

N.B. L'azienda si riserva insindacabilmente di apporre variazioni tecniche e/o commerciali

MADE IN ITALY

 Via Maurizio Iaconelli 16d, 00030 San Cesareo (RM)

 +39 06 95595017

 info@krostechnik.it

 www.krostechnik.it

-  OTTICO
-  230V
-  ACUSTICO*
-  INSTALLAZIONE PER INTERNI

KIT udienza + console - MINI TOA

STAND ALONE

 MINI TOA 1224
 + CONSOLE 2 INTERRUITORI
 CON ALIMENTATORE INTERNO

KIT segnalazione ottico-acustico - UDIENZA

CODICE	ARTICOLO	ALIMENTAZIONE
 9KITUD0051	KIT UDIENZA + CONSOLE	230V
 9KITUD0052	COURT HEARING KIT	230V

Composto da:

Q.TÀ	ARTICOLO	DESCRIZIONE
2	MINI TOA 1224	Mini targa ottico-acustica 12-24Vcc
1	CONSOLE 2 INT	Console 2 interruttori LIBERO-OCCUPATO
1	PORTA CONSOLE	Porta console da tavolo

DIMENSIONI TARGA

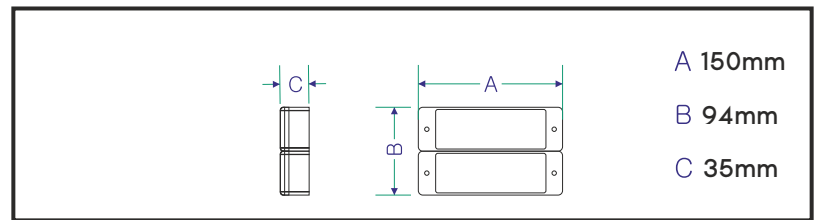

* POSSIBILITÀ DI INIBIRE LA SEGNALAZIONE ACUSTICA TRAMITE JUMPER

-  OTTICO
-  230V
-  ACUSTICO*
-  INSTALLAZIONE PER INTERNI

KIT udienza RX via radio - MINI TOA

STAND ALONE

 CONNESSIONE WIRELESS
 VIA RADIO

 MINI TOA 1224
 MINI TARGA OTTICO-ACUSTICA

KIT segnalazione ottico-acustico - UDIENZA RX VIA RADIO

CODICE	ARTICOLO	ALIMENTAZIONE
 9KITUD0004	KIT UDIENZA RX	230V
 9KITUD0005	COURT HEARING KIT RX	230V

Composto da:

Q.TÀ	ARTICOLO	DESCRIZIONE
2	MINI TOA 1224	Mini targa ottico-acustica 12-24Vcc
1	CONSOLE 2 INT	Console 2 interruttori LIBERO-OCCUPATO-TX
1	PORTA CONSOLE	Porta console da tavolo

DIMENSIONI TARGA

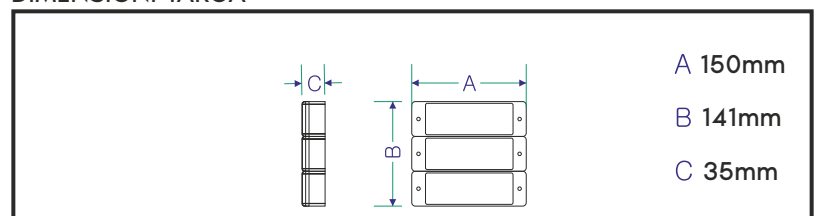

* POSSIBILITÀ DI INIBIRE LA SEGNALAZIONE ACUSTICA TRAMITE JUMPER

 CONSOLE 2 INTERRUITORI VIA RADIO
 CON ALIMENTATORE INTERNO

-  OTTICO
-  230V
-  ACUSTICO *
-  INSTALLAZIONE PER INTERNI

KIT precedenza 230V - MINI TOA

STAND ALONE

KIT segnalazione ottico-acustico - PRECEDENZA

CODICE	ARTICOLO	ALIMENTAZIONE
 9KITPRO002	KIT PRECEDENZA 230V	230V
 9KITPRO003	PRIORITY KIT	230V

Composto da:

Q.TÀ	ARTICOLO	DESCRIZIONE
3	MINI TOA 1224	Mini targa ottico-acustica 12-24Vcc
1	CONSOLE 2 INT	Console 2 interruttori OCCUPATO-ATTENDERE-LIBERO

Opzionale:

Q.TÀ	ARTICOLO	DESCRIZIONE
1	SINO-MINITOA-R-G-V 12	Sinottico via filo 3 luci LED R-G-V 12V
1	PORTA CONSOLE	Porta console da tavolo



VIA FILO
MINI TOA 1224
+ CONSOLE 2 INTERRUTTORI
CON ALIMENTATORE INTERNO



(OPZIONALE)
SINOTTICO VIA FILO
3 LUCI LED R-G-V 12V



(OPZIONALE)
PORTA CONSOLE
DA TAVOLO

DIMENSIONI TARGA

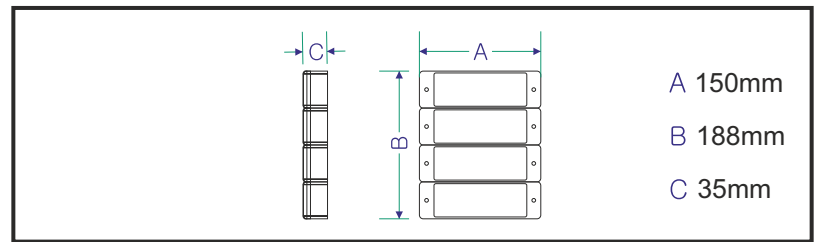

* POSSIBILITÀ DI INIBIRE LA SEGNALAZIONE ACUSTICA TRAMITE JUMPER

-  OTTICO
-  230V
-  ACUSTICO *
-  INSTALLAZIONE PER INTERNI

KIT precedenza RX via radio - MINI TOA

STAND ALONE

KIT segnalazione ottico-acustico - PRECEDENZA RX VIA RADIO

CODICE	ARTICOLO	ALIMENTAZIONE
 9KITPRO004	KIT PRECEDENZA RX	230V
 9KITPRO005	PRIORITY KIT RX	230V

Composto da:

Q.TÀ	ARTICOLO	DESCRIZIONE
3	MINI TOA 1224	Mini targa ottico-acustica 12-24Vcc
1	CONSOLE 3 INT	Console 3 interruttori OCCUPATO-ATTENDERE-LIBERO

Opzionale:

Q.TÀ	ARTICOLO	DESCRIZIONE
1	TX-SEGN	Radiocomando per targhe di segnalazione
1	SINO-MINITOA-R-G-V 12	Sinottico via filo 3 luci LED R-G-V 12V
1	PORTA CONSOLE	Porta console da tavolo

CONNESSIONE WIRELESS
VIA RADIO



MINI TOA 1224
MINI TARGA OTTICO-ACUSTICA



CONSOLE 3 INTERRUTTORI VIA RADIO
CON ALIMENTATORE INTERNO

(OPZIONALE)



TX-SEGN
RADIOCOMANDO

(OPZIONALE)



SINOTTICO VIA FILO
3 LUCI LED R-G-V 12V

(OPZIONALE)



PORTA CONSOLE
DA TAVOLO

DIMENSIONI TARGA

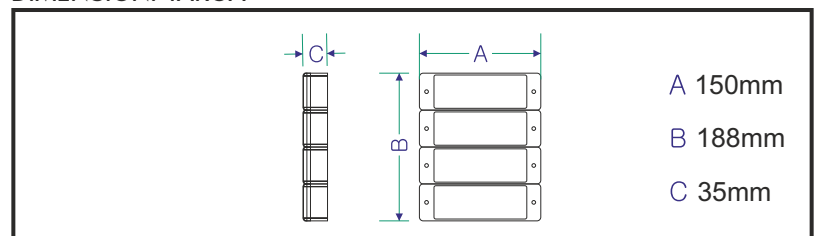

* POSSIBILITÀ DI INIBIRE LA SEGNALAZIONE ACUSTICA TRAMITE JUMPER

-  OTTICO
-  230V
-  ACUSTICO *
-  INSTALLAZIONE PER INTERNI

KIT semaforo 230V - MINI TOA

STAND ALONE



MINI TOA 1224 + CONSOLE 2 INTERRUITORI



KTALM123
ALIMENTATORE 400mA 12V

KIT segnalazione ottico-acustico - SEMAFORO

	CODICE	ARTICOLO	ALIMENTAZIONE
	9KITSE0002	KIT SEMAFORO 230V	230V
	9KITSE0004	TRAFFIC LIGHT KIT 230V	230V

Composto da:

Q.TÀ	ARTICOLO	DESCRIZIONE
2	MINI TOA 1224	Mini targa ottico-acustica 12-24Vcc
1	CONSOLE 2 INT	Console 2 interruttori STOP-AVANTI
1	KTALM123	Alimentatore 400mA 12V (supporta fino a 4 targhe)

DIMENSIONI TARGA

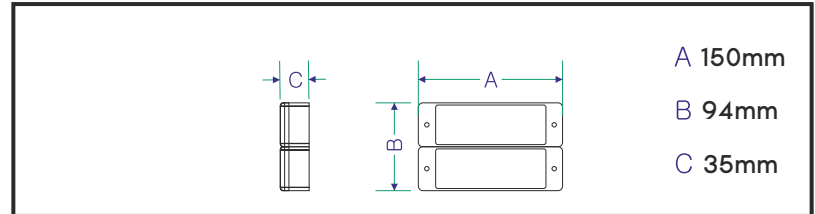

* POSSIBILITÀ DI INIBIRE LA SEGNAZIONE ACUSTICA TRAMITE JUMPER

-  OTTICO
-  230V
-  ACUSTICO *
-  INSTALLAZIONE PER INTERNI

KIT semaforo bifacciale - MINI TOA

STAND ALONE

FISSAGGIO A PARETE



TARGA BIFACCIALE PRT

FISSAGGIO A SOFFITTO



TARGA BIFACCIALE SFT





KTALM123
ALIMENTATORE 400mA 12V



CONSOLE 2 INTERRUITORI

KIT segnalazione ottico-acustico - SEMAFORO BIFACCIALE

	CODICE	ARTICOLO	ALIMENTAZIONE
	9KITSE0005	KIT SEMAFORO BIF-PRT	230V
	9KITSE0006	KIT SEMAFORO BIF-SFT	230V
	9KITSE0007	DS WALL TRAFFIC LIGHT KIT	230V
	9KITSE0008	DS CEILING TRAFFIC LIGHT KIT	230V

Composto da:

Q.TÀ	ARTICOLO	DESCRIZIONE
4	MINI TOA 1224	Mini targa ottico-acustica 12-24Vcc
1	STF-2TOA	Staffa in acciaio inox
1	CONSOLE 2 INT	Console 2 interruttori STOP-AVANTI
1	KTALM123	Alimentatore 400mA 12V (supporta fino a 4 targhe)

DIMENSIONI TARGA

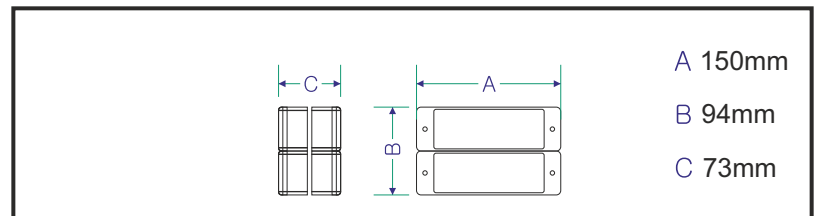

* POSSIBILITÀ DI INIBIRE LA SEGNAZIONE ACUSTICA TRAMITE JUMPER

-  OTTICO
-  230V
-  ACUSTICO *
-  INSTALLAZIONE PER INTERNI

KIT semaforo RX via radio - MINI TOA

STAND ALONE

 CONNESSIONE
 WIRELESS
 VIA RADIO

 MINI TOA 1224
 MINI TARGA OTTICO-ACUSTICA

 CONSOLE 2 INTERRUTTORI
 VIA RADIO

 KTALM123
 ALIMENTATORE 400mA 12V

 TX-SEGN
 RADIOCOMANDO

KIT segnalazione ottico-acustico - SEMAFORO RX VIA RADIO

CODICE	ARTICOLO	ALIMENTAZIONE
 9KITSE0009	KIT SEMAFORO RX	230V
 9KITSE0010	TRAFFIC LIGHT RX	230V

Composto da:

Q.TÀ	ARTICOLO	DESCRIZIONE
2	MINI TOA 1224	Mini targa ottico-acustica 12-24Vcc
1	CONSOLE 2 INT	Console 2 interruttori STOP-AVANTI
1	KTALM123	Alimentatore 400mA 12V (supporta fino a 4 targhe)
1	TX-SEGN	Radiocomando per gestione targhe di segnalazione

DIMENSIONI TARGA

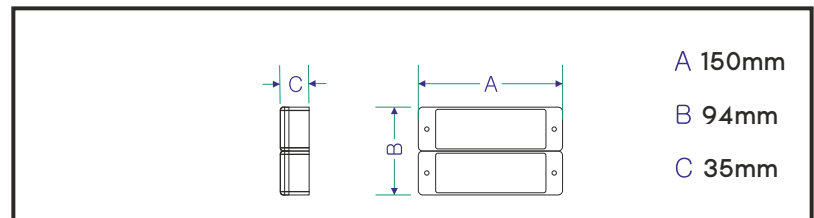

* POSSIBILITÀ DI INIBIRE LA SEGNALAZIONE ACUSTICA TRAMITE JUMPER

KIT precedenza - TOA-503

STAND ALONE

 ALIMENTATORE A SPINA
 IN 230V - OUT 12V

 CONSOLE DA TAVOLO
 IN 12V

TARGA FUORI PORTA 503



Alimentazione: 230V
 Temperatura operativa: -5°C / +50°C
 Fabbricazione corpo: 100% Italiana
 Fabbricazione elettrica: 100% Italiana
 Fabbricazione elettronica: 100% Italiana
 Materiale: Policarbonato autoestinguente V2
 Colore: Antracite
 Doppio isolamento
 Conforme alle norme vigenti

KIT segnalazione incasso 503 - PRECEDENZA

CODICE	ARTICOLO
01330WAY	KIT PRECEDENZA 503-01-230V

Composto da:

Q.TÀ	ARTICOLO	DESCRIZIONE
1	ALM-SPINA	Alimentatore a spina IN230V - OUT 12V
1	P/503N-TAVOLO	Console da tavolo - IN 12V
1	TOA-L/O/A-12V	Targa fuori porta 503

DIMENSIONI TARGA

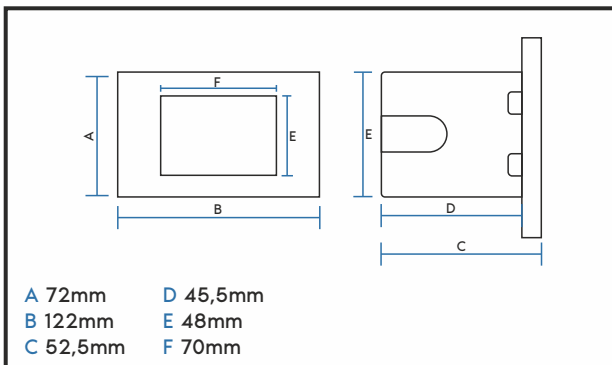

«UNIVERSALE»
 INSTALLAZIONE AD INCASSO
 IN SCATOLA 503
 DA MURO
 DA CARTONGESSO
 OPPURE
 DA TAVOLO CON ACCESSORIO

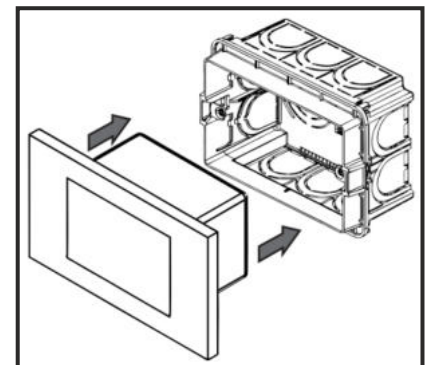

MADE IN ITALY

LA DIFFERENZA È LA QUALITÀ



KROS TECHNIK s.r.l.
Via Maurizio Iaconelli 16 D, 00030 - San Cesareo (Roma)
Tel. +39 06 95595017 / +39 347 3214931
email: info@krostechnik.it
website: www.krostechnik.it



Contact us:    

www.krostechnik.it

K
I
T

U
D
I
E
N
Z
A